

## U 200x35

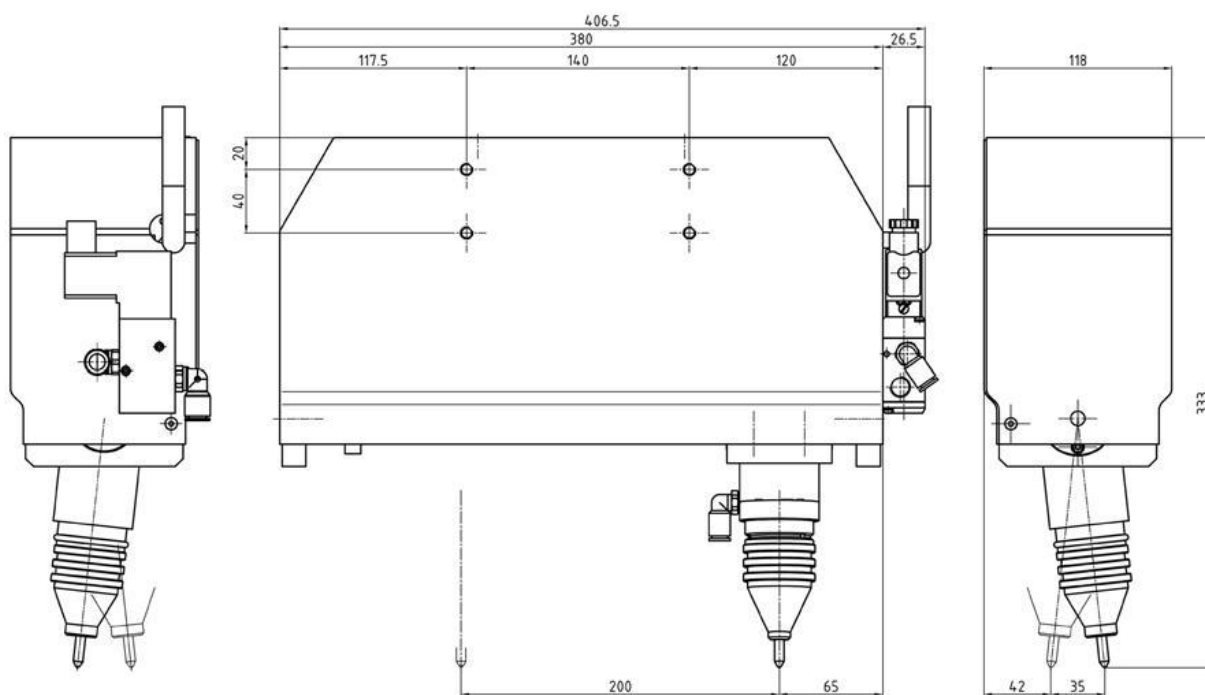

Notatki: